

SENTRY GT / SENTRY GT..KD40

Thermal Cut-Off Devices and Ball Valves

CE 0085

Complies with the German FeuVO and Pressure Equipment Directive 97/23/EC



DESCRIPTION

SENTRY GT Thermal Cut-off Devices (TCO) help prevent gas from flowing to downstream components that may not be resistant to high temperatures. These thermal cut-off devices automatically shut off the gas flow at temperatures between 92 °C and 100 °C. The SENTRY GT..KD40 ball valve may also be used as a main gas manual shut-off valve.

SENTRY GT Thermal Cut-off Device

The release mechanism (temperature sensor) retains the closing unit, which is mounted under spring pressure. At the release temperature, the release mechanism unblocks the closing unit, and the closing unit moves into the seat resulting in a gas-tight seal. The SENTRY GT remains closed after it cools. (See figure 2, page 2.)

Ball Valve SENTRY GT..KD

To close the ball valve, the lever must be turned clockwise \curvearrowright 90°. To open, turn the lever counterclockwise \curvearrowleft 90°. The ball valve is open when the lever is in the flow direction of the pipe (see figure 3, page 2). The ball valve should be opened slowly to avoid pressure surge.

CERTIFICATION

SENTRY GT TCOs meet the requirements of:

- *General Gas Guidance IGEM/G/5 Gas in multi-occupancy buildings and are certified in compliance with:*
- *Pressure Equipment Directive 97/23/EC*
- *German FeuVO*
- *DIN 3586*
- *DVGW-Code of Practice G600 (TRGI-2018)*

German fire code draft recommendation 02/95, Edition 09/97, the legal basis for Germany's regional buildings and fire codes, mandates the use of a thermally activated shut-off device.

Gas pipes supplying gas appliances must be equipped with a device:

1. That automatically shuts off the gas flow when subjected to temperatures above 100 °C.
2. That allows no more than 30 l/h measured in air to pass through or escape from the device for a period of at least 30 minutes at temperatures up to 650 °C (Maxitrol tested up to 925 °C) when tripped. (Figure 1, page 2 shows that during a fire the temperature reaches 700 °C within 15 minutes.)

This requirement does not apply to gas appliances already equipped with a thermally activated shut-off device.

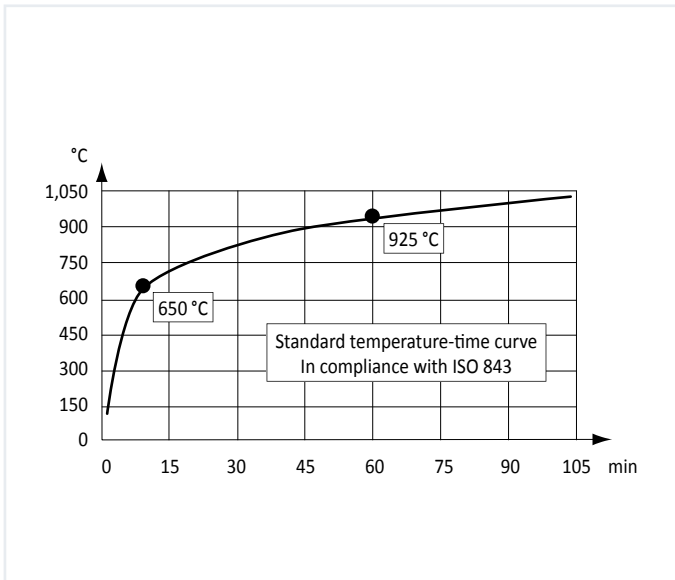

Figure 1: Temperature rise in a test room fire simulation

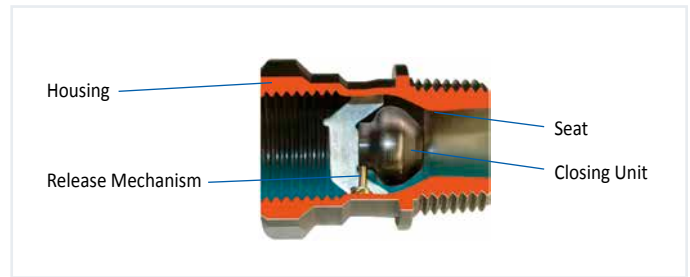

Figure 2: Cross-section of a SENTRY GT (GT15DIA) thermally activated shut-off device



Figure 3: Example of a SENTRY GT..KD40 installed

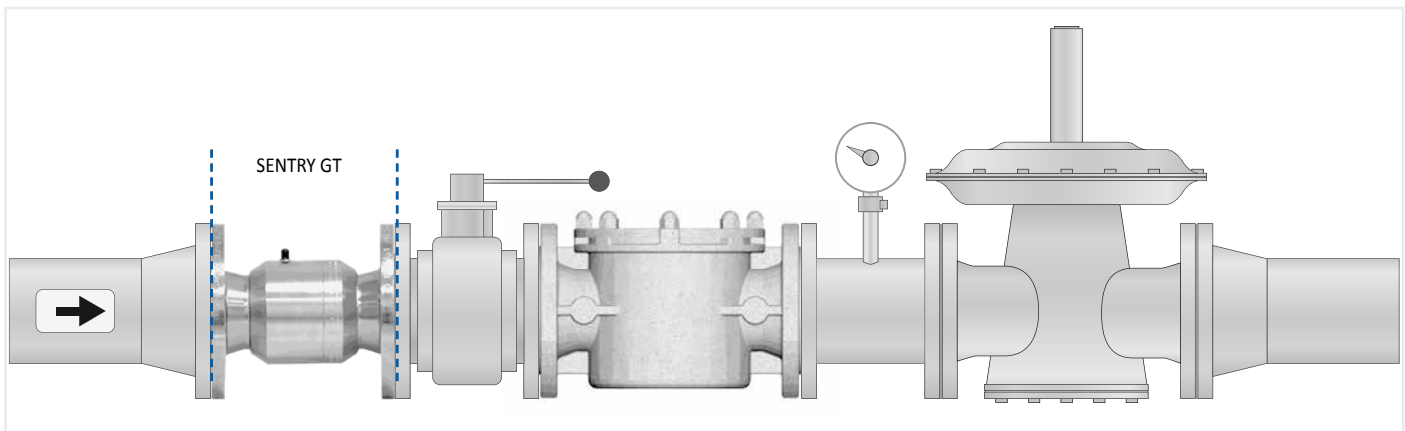

Figure 4: Example of a SENTRY GT installed upstream of a burner

TECHNICAL DATA

Technical data	SENTRY GT	SENTRY GT..KD40
Threaded connection	DIN EN 10226-1 / ISO 7-1	DIN EN 10226-1 / ISO 7-1
Flanged connection	DIN EN 1092-1:2018-12 (PN 16) / ISO 7005-1	-
Gas types	DIN EN 437; DVGW G 262	DIN EN 437
Release temperature	100 °C – 8 K	100 °C – 8 K
Nominal pressure	MOP 5 (PN 5, DIN 3586)	MOP 5 (PN 5, DIN 3586)
Allowable leakage	< 30 l/h air at 650 °C	< 30 l/h air at 650 °C
Max. ambient temperature	80 °C	60 °C
Thermal rating	30 min 650 °C in compliance with DIN 3586; max. 925 °C (in compliance with ISO 843 max. 1 hour)	30 min 650 °C in compliance with DIN 3586; max. 925 °C
Material	Steel	Brass, Steel

Certifications / Range of use	SENTRY GT	SENTRY GT..KD40
Pressure Equipment Directive	97/23/EC	97/23/EC
DVGW	DN 10 -150: DIN 3586 DN 32 -150: DIN 3586 DVGW TRF 2012 DVGW TRGI 2018	DIN EN 331; DIN 3586

FLOW RATE CHARTS (Natural Gas d = 0.6; pi = 2.5 kPa)

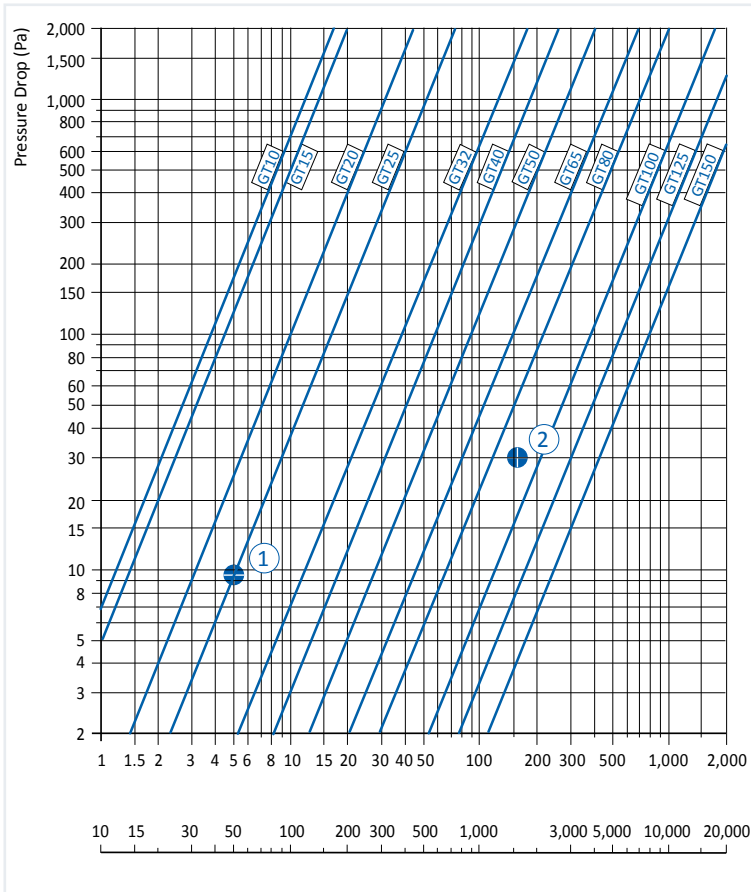

Figure 5: Sentry GT Flow Rate Chart

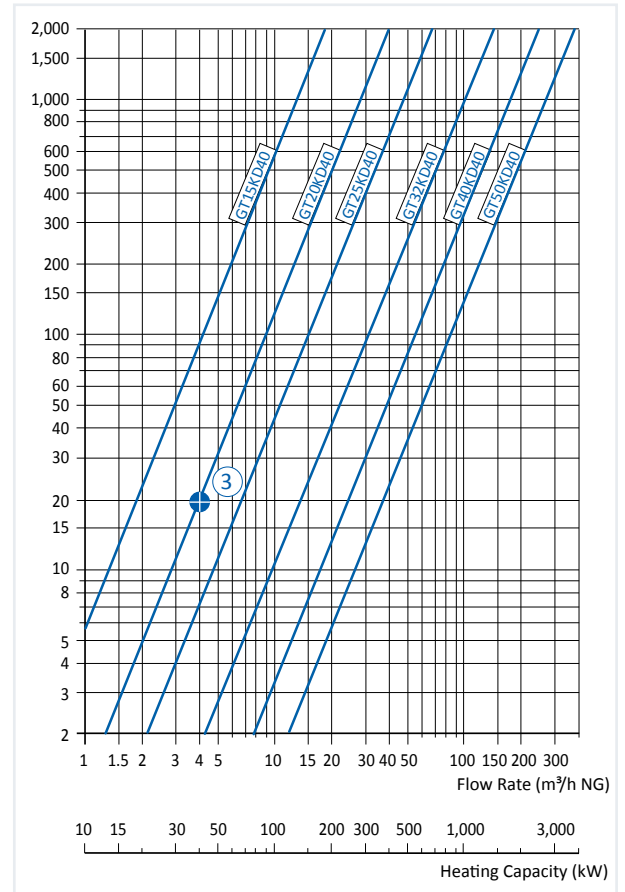

Figure 6: Sentry GT..KD40 Flow Rate Chart

FLOW RESISTANCE FACTOR

Flow resistance factor ζ (zeta) for SENTRY GT

DN10	DN15	DN20	DN25	DN32	DN40	DN50	DN65	DN80	DN100	DN125	DN150
1.5	4.5	3.0				1.5					1.8

EXAMPLES (see figure 5 and 6)

- ① For a 50 kW boiler with a flow rate of ca. 5 m³/h natural gas, the pressure drop for a GT25 would be 9.5 Pa.
- ② The pressure drop of a GT for a 1500 kW boiler may not exceed 30 Pa. Choose the next characteristic line below plot point ② (GT100).
- ③ The pressure drop of a GT20KD40 with a flow rate of 4 m³/h natural gas would be 20 Pa.

INSTALLATION KIT FOR SENTRY GT

In compliance with applicable industry standards, an installation kit is required for the installation of flanged versions of thermal cut-off devices. This kit consists of high temperature resistant flange gaskets, hexagonal screws and hexagonal nuts. All flanged units must use high temperature resistant gaskets in compliance with Standard DIN EN 1092-1:2018-12 (PN 16) / ISO 7005-1. Only use high temperature resistant flange gaskets in compliance with DIN 30653 (HTR) up to 5 bar (Marked by: 3 red marks staggered 120°). For a list of high temperature resistant gasket kits see Maxitrol literature GT-DS-DE.EN...

Installation Kit	Nominal diameter
SENTRY GT 32 M2(3) (for SENTRY GT32FF)	DN32
SENTRY GT 40 M2(3) (for SENTRY GT40FF)	DN40
SENTRY GT 50 M2(3) (for SENTRY GT50FF)	DN50
SENTRY GT 65 M2(3) (for SENTRY GT65FF)	DN65
SENTRY GT 80 M2(3) (for SENTRY GT80FF)	DN80
SENTRY GT 100 M2(3) (for SENTRY GT100FF)	DN100
SENTRY GT 125 M2(3) (for SENTRY GT125FF)	DN125
SENTRY GT 150 M2(3) (for SENTRY GT150FF)	DN150

MODELS / DIMENSIONS

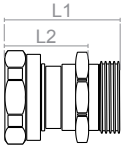
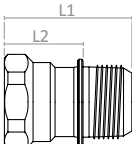
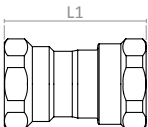
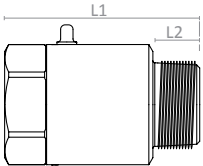
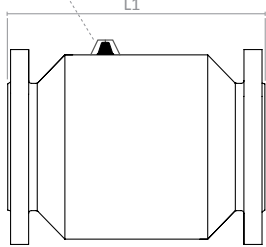
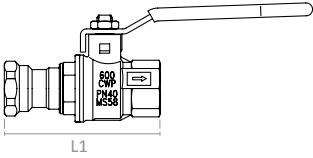
Illustration	Type (Order Code)	Connection		Surface	Dimensions [mm]			Weight [kg]	Cert. No.
		Inlet	Outlet		L1	L2	SW Wrench size		
	GT20BLC0	Internal thread 3/4 BS746	External thread 3/4 BS746	blue galvanized	45.0	33.0	36	0.136	CE-0085BN0394
	GT10DIA0 GT15DIA0 GT20DIA0	Internal thread Rp 3/8 Rp 1/2 Rp 3/4	External thread R 3/8 R 1/2 R 3/4	blue galvanized	40.0 40.0 50.3	28.4 24.7 34.0	22 27 32	0.05 0.07 0.10	CE-0085BN0394
	GT25DIA2	Rp 1	R 1	black galvanized	53.8	34.6	41	0.21	
	GT15DII0 GT20DII0	Internal thread Rp 1/2 Rp 3/4	Internal thread Rp 1/2 Rp 3/4	blue galvanized	45.5 54.5	- -	27 32	0.10 0.15	CE-0085BN0394
	GT25DII2	Rp 1	Rp 1	black galvanized	61.5	-	41	0.30	
	GT32IA4 GT40IA4 GT50IA4	Internal thread Rp 1 1/4 Rp 1 1/2 Rp 2	External thread R 1 1/4 R 1 1/2 R 2	nickel plated	100.0 112.0 135.0	21.4 21.4 25.7	55 65 80	0.76 1.46 2.52	CE-0085BN0395
	GT32II4 GT40II4 GT50II4	Rp 1 1/4 Rp 1 1/2 Rp 2	Internal thread Rp 1 1/4 Rp 1 1/2 Rp 2		100.0 112.0 135.0	- - -	55 65 80	1.14 1.76 2.60	
DN150 protection cage 	GT32FF4 GT40FF4 GT50FF4 GT65FF4 GT80FF4 GT100FF4* GT125FF* GT150FF*	Flange connection DN32 DN40 DN50 DN65 DN80 DN100 DN125 DN150	Flange connection DN32 DN40 DN50 DN65 DN80 DN100 DN125 DN150	nickel plated	138.0 155.0 175.0 197.0 229.0 267.0 224.0 268.0	- - - - - - - -	- - - - - - - -	2.50 3.70 6.10 7.80 11.00 15.30 26.00 32.00	CE-0085BN0394 / CE-0085BN0395
	GT15KD40 GT20KD40	Internal thread Rp 1/2 Rp 3/4	Internal thread Rp 1/2 Rp 3/4	nickel plated / blue galvanized	75.5 90.0	- -	27 32	0.25 0.40	CE-0085AQ1219 CE-0085BN0394 / CE-0085BN0395
	GT25KD40	Rp 1	Rp 1	nickel plated / black galvanized	121.0	-	41	0.75	
	GT32KD40 GT40KD40 GT50KD40	Rp 1 1/4 Rp 1 1/2 Rp 2	Rp 1 1/4 Rp 1 1/2 Rp 2	nickel plated	185.0 207.0 246.0	- - -	55 65 80	1.62 2.54 3.86	

OPTIONS

To order a biogas resistant version of the DN 32 through DN 100, replace the "4" with a "9" at the end of the order code (e.g. GT32FF9). To order a biogas resistant version of the DN 125 and DN 150 add a "9" to the end of the order code (e.g. GT150FF9).

In addition to the standard versions listed in the table above, Custom inlet and outlet connections are available.